

Type No. 82064

nominal voltage		12 V
nominal capacity at +25°C	20h	64 Ah
nominal discharge current	I20	3,2 A
recommended charge voltage at +25°C	1)	14,4 V
maximum charge voltage at +25°C	1)	14,8 V
recommended charge current at +25°C	3)	6,4 A
maximum charge current at +25°C	1)	32 A
box size		H5 / LN 2
length	max.	242 mm
width	max.	175 mm
height	max.	190 mm
weight wet charged	ca. 2)	17,3 kg
MOLL KAMINA central degassing inside the lid		X
MOLL K2 double lid		X
plug degassing		-
terminal position		0
terminal type		1
base hold down		B3/B13
cold cranking current at -18°C SAE EN		620 A
electrolyte density at +25°C (diluted sulfuric acid)		1,29 +/- 0,01 kg/l
durability according EN50342-1		E3
charge retention according EN50342-1		C2
water consumption according EN50342-1		W4
vibration resistance according EN50342-1		V3
micro cycles according EN50342-6		M2

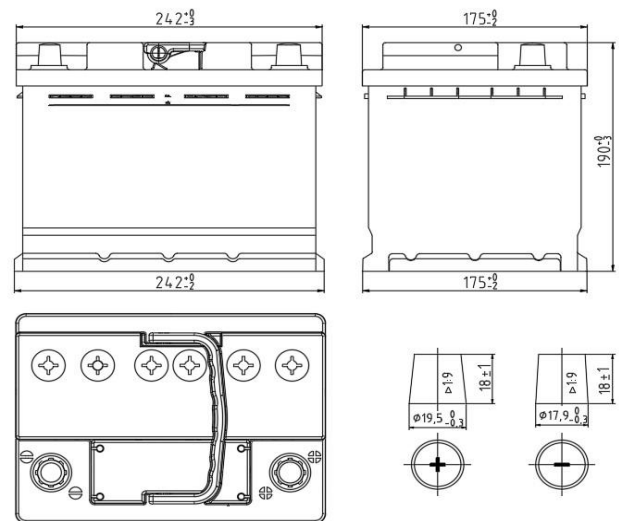

at open-circuit voltage ≤ 12,5 V: recharge battery

- 1) Applicable for charging with external charging devices outside of the car's electrical system.
ATTENTION: Please make absolutely sure that the battery is disconnected from the vehicle's electrical system!
For different temperatures, make sure to adjust the charge voltage according to the documentation TEMPERATURE COMPENSATION https://www.moll-batterien.de/T-Kompensation_en.pdf.
- 2) Production reach is ± 5 % - errors and omissions excepted!
- 3) Serves as decision guidance for a suitable battery charger.
In general, the charging should be voltage regulated according to 1).



date: 13.11.2024

This data sheet contains confidential data, is not binding and may be changed without prior notice.
Any use, copying or distribution must be approved in writing by MOLL batteries.

MOLL Batterien GmbH
Angerstraße 50
96231 Bad Staffelstein
Germany

Tel.: +49 (0)9573 9622-0
E-Mail: info@moll-batterien.de
www.moll-batterien.de

